

**Models 4640-2 • 4640-3**

Effective: September, 2015 (Revised 06-14-21)

EX-1819

# Installation and Operations Manual



**Table of Contents**

Tank Level Status Display..... page 3

Specifications — Model 4640-2 ..... page 4

Specifications — Model 4640-3 ..... page 4

24 Vdc Output - Enable/Disable Transmitter Excitation..... page 8

Datapak iButton (installation) ..... page 9

Keypad Entry - Specific Gravity..... page 11

Keypad Entry - Password Enable..... page 12

Troubleshooting Checklist ..... page 14

Diagnostic Codes (troubleshooting)..... page 15

Addendum; ASCII communications format..... page 16

**Warranty** - All KING-GAGE, A NOSHOK Company products are guaranteed to be free from defects in material and workmanship for one year from the date of purchase. Any product or part found to be defective under normal use within one year of purchase will be repaired or replaced at no charge if returned to the company in Berea, Ohio within a reasonable time of its discovery. No other warranties, whether expressed, implied or statutory, including the warranties of fitness for a particular purpose or merchantability, are given by this agreement. The exclusive remedy for nonconformity of these goods shall be repair and/or replacement of the nonconforming goods or parts.

Seller will not be liable for consequential damages resulting from breach of this agreement. The term "consequential damages" shall include but shall not be limited to damage to all machines, equipment and goods other than the goods sold hereby, interruption of production, loss of profits, delays of any kind, administrative expense and overhead.

**Revisions:**

- (A) March, 2007 – Original Release (LP2 Version)
- (B) Sept. 2015 - updated configuration w/ keypad

Specifications subject to change without notice.

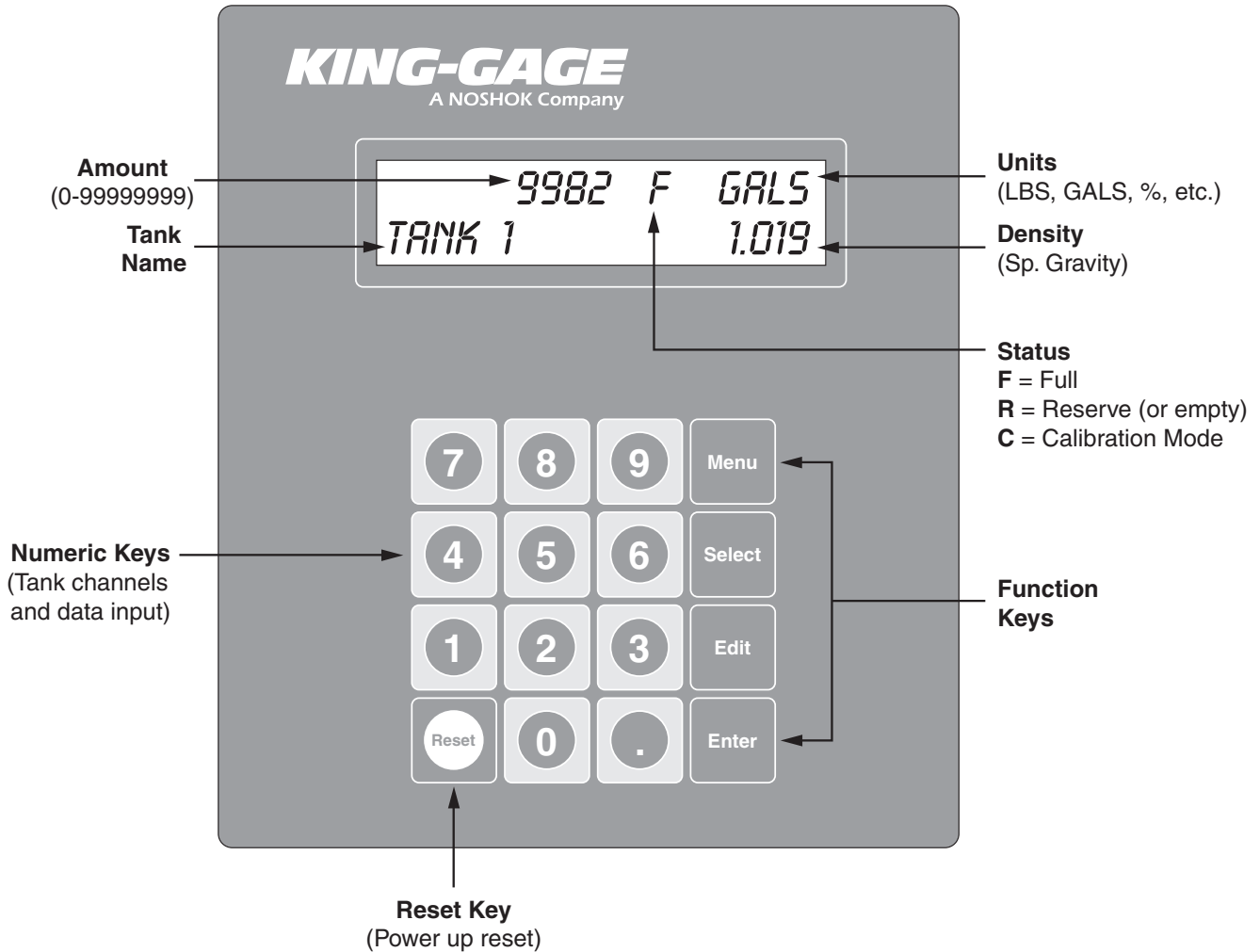

### KING-GAGE LP2™ Tank Level Display

The LP2 tank level indicator expresses output directly in engineering units. The processor references a capacity profile to correlate transmitter output to actual tank geometry. The processor then formats the resulting value directly as the total weight or volume of liquid in the tank. Unlike digital panel meters, there are no user conversion factors involved or scaling points to enter. All application details have been factory programmed into the nonvolatile memory Datapack iButton.

### Input Requirements

LP2 tank level indicator accepts standard proportional 4-20 mA output from the liquid level transmitter. The sensor used to detect hydrostatic pressure (created by liquid depth) can be either electronic or pneumatic. With the latter, an electronic pressure transmitter is used to convert the sensor's pneumatic signal into a 4-20 mA output. This can be done with a KING-GAGE® D/P Module or D/P Transmitter.

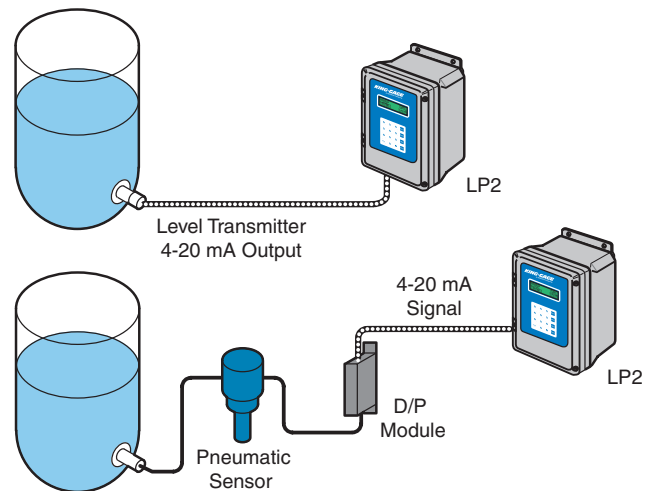

**Specifications – 4640-2**

- **Power Requirements**  
100-240 Vac, 50-60 Hz, 25 watts  
(fused internally for 2.5 A 120/250 V)
- **Temperature Range** (Environmental)  
30°F to 120°F (-1°C to 49°C)  
operating range
- **Signal Input**  
4-20 milliamperes (mA<sub>dc</sub>)
- **Power Output**  
24 Vdc nominal; fused @ 0.5 Amp
- **Input Impedance** (Resistance)  
120 ohm nominal (2.4 Vdc drop @ 20 mA<sub>dc</sub>)
- **Memory**  
Nonvolatile 64kbit memory iButton
- **Digital Readout**  
Alphanumeric 0.3173 in. (8 mm)  
16-character x 2-line LCD; numeric  
8-digit (0-99999999 maximum)
- **Keypad**  
Membrane numeric keypad, five (5)  
function keys, positive tactile response
- **Accuracy**  
±0.048% FS (±0.024% FS, typical)
- **Resolution**  
±0.024% FS maximum (±0.004 mA)
- **Communications**  
Two (2) serial EIA-485 ports; two wire  
multidrop
- **Enclosure**  
Engineered thermoplastic (NORYL)  
enclosure; UL 50, NEMA type 3, 3S, 4,  
4X, 12; hinged cover with dual latching  
screws.

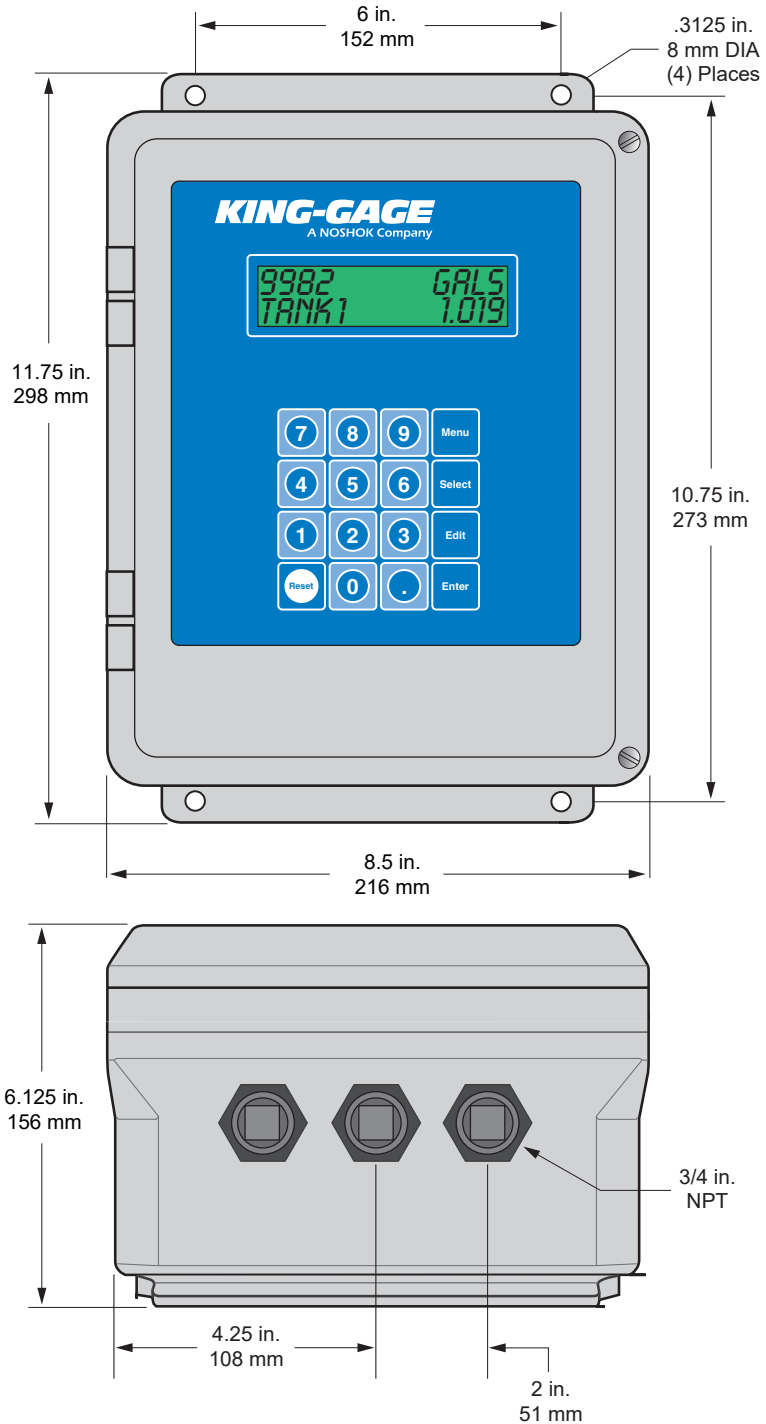

**Model 4640-2**

**Specifications – 4640-3**

- **Power Requirements**  
100-240 Vac, 50-60 Hz, 25 watts (fused internally for 2.5 A 120/250 V)
- **Temperature Range** (Environmental)  
30°F to 120°F (-1°C to 49°C) operating range
- **Signal Input**  
4-20 milliamperes (mA<sub>dc</sub>)
- **Power Output**  
24 Vdc nominal; fused @ 0.5 Amp
- **Input Impedance** (Resistance)  
120 ohm nominal (2.4 Vdc drop @ 20 mA<sub>dc</sub>)
- **Memory**  
Nonvolatile 64kbit memory iButton
- **Digital Readout**  
Alphanumeric 0.3173 in. (8 mm) 16-character x 2-line LCD; numeric 8-digit (0-99999999 maximum)
- **Keypad**  
Membrane numeric keypad, five (5) function keys, positive tactile response
- **Accuracy**  
±0.048% FS (±0.024% FS, typical)
- **Resolution**  
±0.024% FS maximum (±0.004 mA)
- **Communications**  
Two (2) serial EIA-485 ports; two wire multidrop
- **Enclosure**  
14 gauge stainless steel enclosure; UL 50 types 4, 4X, 12, 13; hinged cover with dual latching screw lugs.

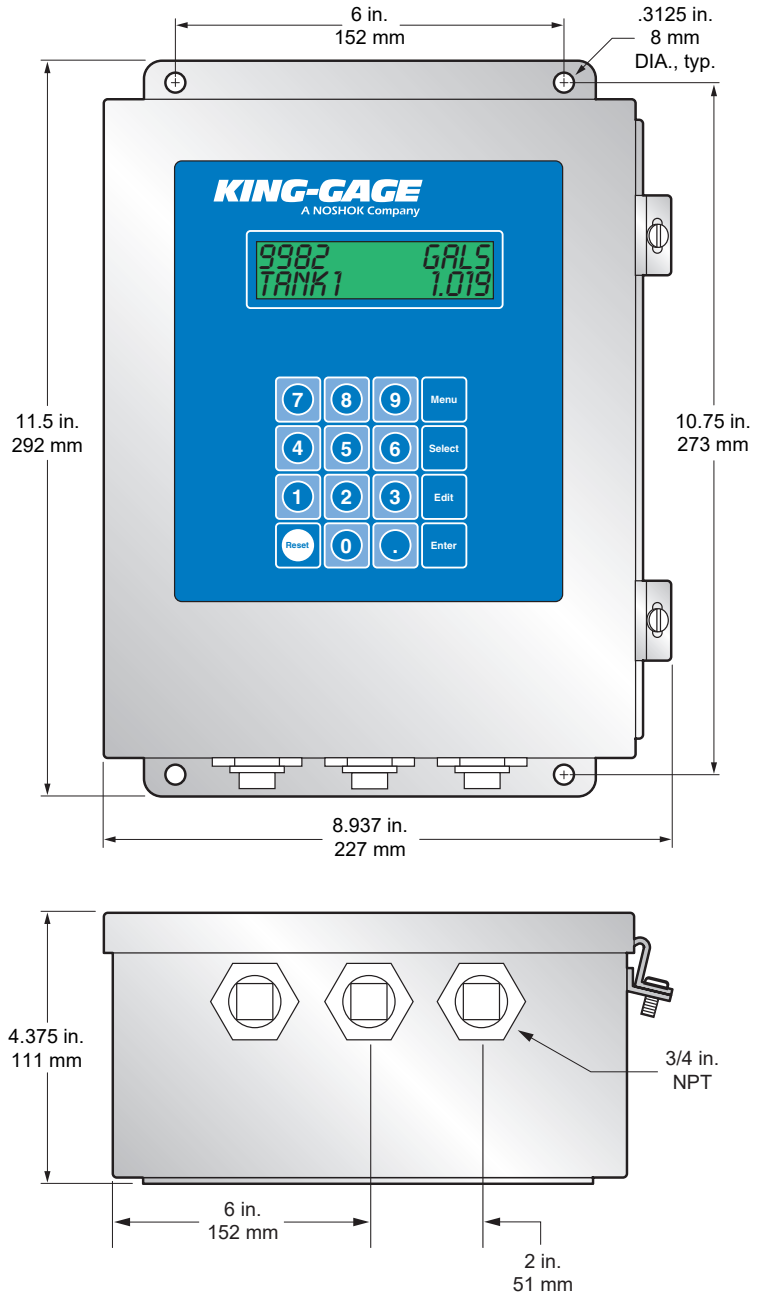

**Model 4640-3**

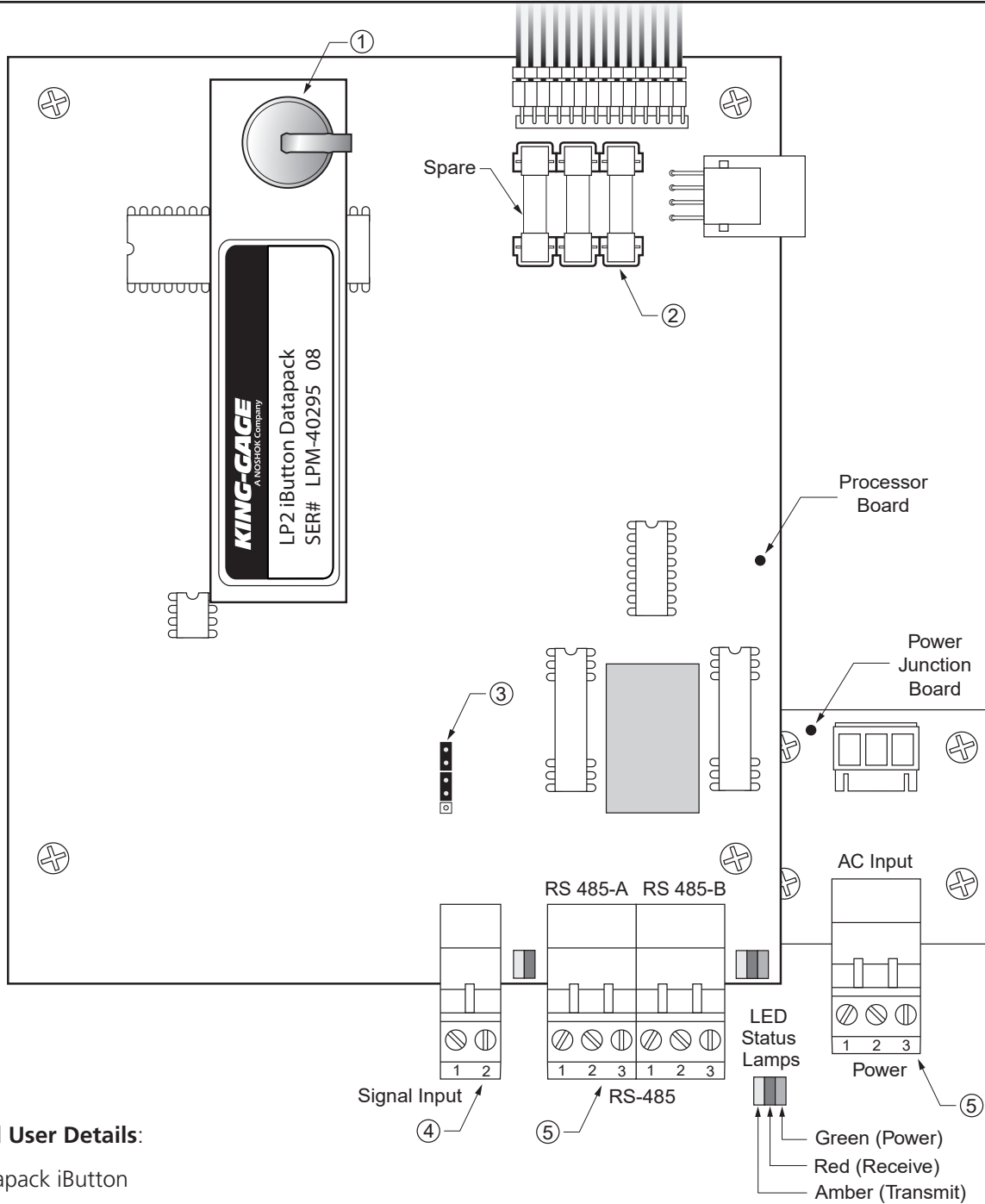

**Internal User Details:**

1. Datapack iButton
2. 1/2 Amp Fuse - 120/250 Volt  
Fast-Blo Order No. 7469-24-0  
(5-pack)
3. Shunt /Jumper ; used in pairs to  
activate or bypass 24Vdc  
excitation.
4. Terminal, Signal Input
5. Serial EIA – 485 communication  
ports(2).
6. 100-240Vac, 50-60 Hz, Power  
input.

**Input Signal  
Connector**

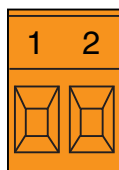

**RS – 485  
Connector**

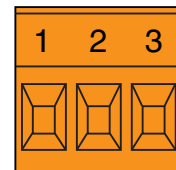

## Installation Requirements

### Mounting -

The LP2 indicator may be mounted at the tank, or up to several thousand feet away. It is important to find a mounting location that affords some degree of protection for the unit. Do not locate where sub-freezing temperatures may be encountered.

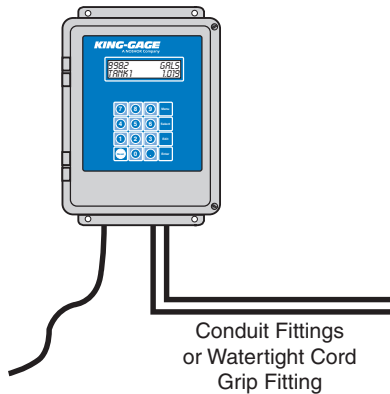

Enclosure should be mounted in an upright position to a wall or other structural member. Cabling access ports are 3/4" NPT and intended for conduit or water-tight cable connectors. Keep unused connections sealed to maintain enclosure integrity. When locating enclosure, maintain adequate clearance for access to bottom connections.

## Signal Input and Electrical Connections

We recommend completing the transmitter input signal (4-20 mA) connections prior to AC power, when practical. Use approved 3-conductor, source grounded power cable for typical 115 Vac connections.

### Input Signal Connector

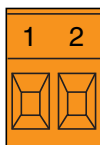

### RS - 485 Connector

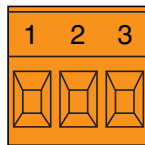

## Transmitter Signal Loop

Typical transmitter provides a 4-20 mA output over a dc-powered two wire current loop circuit. This normally requires at least a 24 Vdc power source to provide excitation voltage to the transmitter. The power requirements should be calculated to accommodate the total resistive load residing on the circuit (e.g., cabling impedance, input impedance of receivers, etc.). Refer to the specific load capacity specifications for the sensor or transmitter being used.

## Signal Cabling

The 4-20 mA signal loop needs to be run using twisted pair (two conductor) cable. "Noise" or EMI (electromagnetic interference) does not generally create a problem since it is common to both wires in the pair and essentially cancels itself out. In most applications, non-shielded twisted pair instrumentation cable (20-22 AWG) will be suitable for the signal loop between the LP2 and sensor/transmitter.

**Recommended Signal Cable:** 20 or 22 AWG twisted pair.

**NOTE:** Shielded twisted pair cable may be used for extremely noisy environments where strong EMI/RFI fields exist. It is critical that shielded cabling be properly earth grounded on one end only. This will guard against the shield from becoming a conductor if improper electrical wiring exists elsewhere in the system or facility. The shield should be grounded to the GND terminal of the earth grounded Vac power connection. (Power supplied to the LP2 processor must be 3-line source with earth ground.)

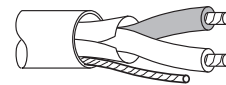

Shielded cable (if used) should be grounded at one end only!

## 24 Vdc Output (Transmitter Excitation)

The LP2 indicator incorporates an internal 24 Vdc supply that can be used to power the signal loop. A pair of shunt/jumpers for each input channel are used to enable or disable this voltage supply across the signal input terminals. The unit is shipped from the factory with the jumpers installed in the ENABLED (B) position to provide 24 Vdc across signal input terminals #1 and #2. If you are using an external power supply, move the jumpers to the DISABLED (A) position. Refer to the illustration showing the location of the shunt/jumpers.

**NOTE:** When configured for external power (DISABLED), all of the affected (-) terminals are connected together in the LP2. The transmitters must be connected to the (+) side of the loop and the (-) side must return directly to the power supply. Be certain to check that the external power supply is "floating" such that the (-) terminal is not directly tied to an earth ground.

**IMPORTANT!** Use caution when connecting signals to analog input cards in computers or PLCs. Many of these are "single ended" in that they tie the signal grounds of many different devices together. This can result in unpredictable current paths and unstable signals.

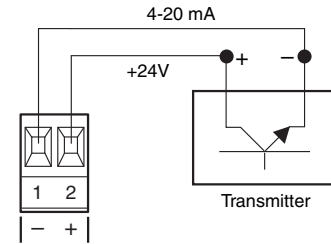

**Detail - Onboard 24 Vdc Output**

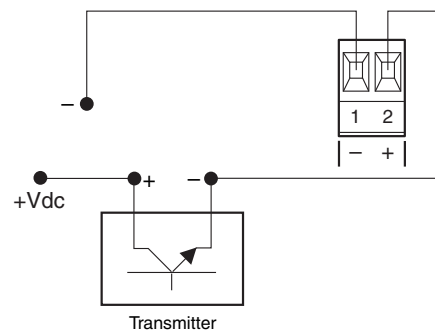

**Detail - External Power Supply**

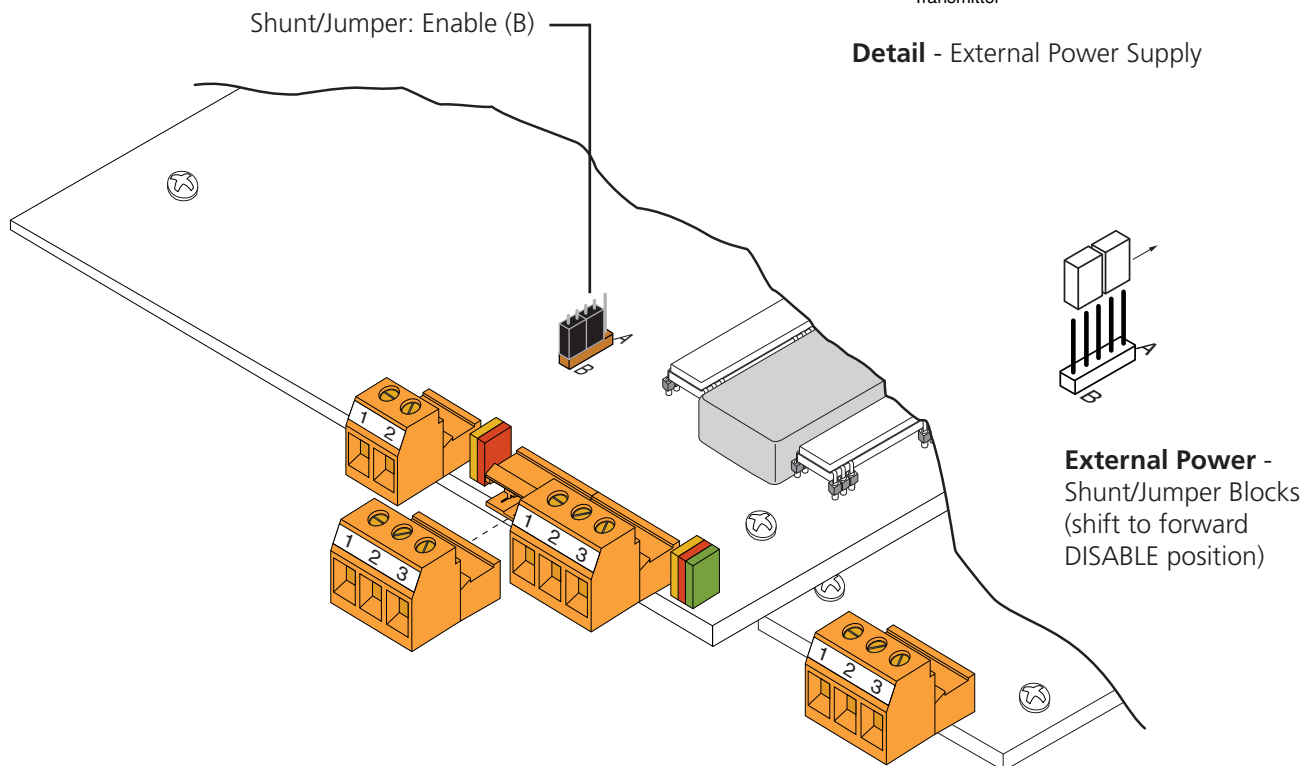



## Application Programming (Datapack)

The LP2 tank level indicator expresses output directly in engineering units. The processor references a capacity profile to correlate transmitter output to actual tank geometry. The processor then displays the resulting value directly as the total weight or volume of liquid in the tank. All application details are factory programmed into nonvolatile memory.

Referred to as the Application Datapack, this iButton memory module contains a default liquid density value, readout units factor and tank name. In addition to battery backup, critical data such as the capacity profile are not user-addressable to prevent any possible corruption of the original factory programming.

**Editing Specific Gravity Value:** This avoids the need to re-range the level transmitter when the tank is used for more than one liquid product density. Specific gravity corresponding to the tank contents. Uses the external communications link to change specific gravity value from a remote terminal or PLC.

## Installing Updated Datapack iButton

Non-addressable application parameters (i.e., tank name, network polling address, tank capacity profile) require updated datapack programmed at the factory. Use caution when accessing the datapack — internal circuitry and electrical connections should not be exposed to moisture. Turn off power to unit prior to handling internal components.

Turn off power or open the enclosure and disconnect the plug-in terminal connector. Datapack (iButton) is readily accessible at the upper portion of the circuit card.

A. To remove datapack, lift up and slide datapack outward (see illustration) to remove datapack.

B. To install datapack, slide datapack under clip. Make certain Datapack iButton is fully seated in socket.

## Troubleshooting Checklist

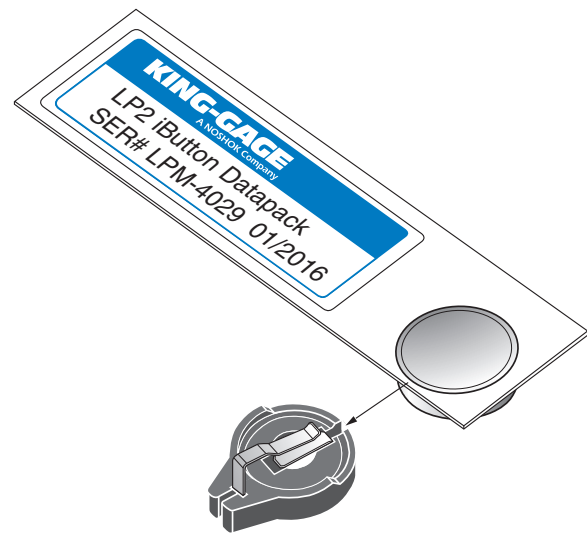

Detail - Datapack iButton and Socket

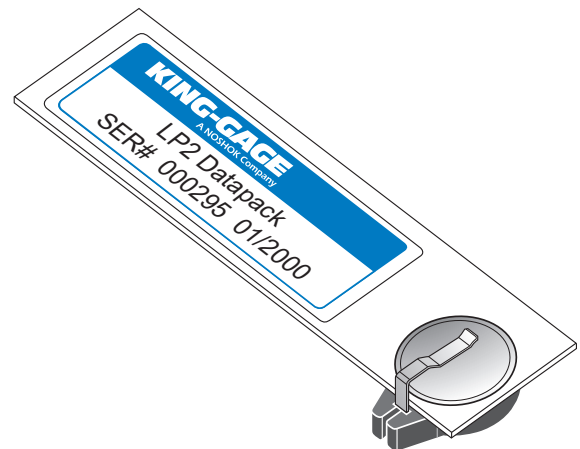

Detail - Datapack iButton installed

## LP2 Display Modes

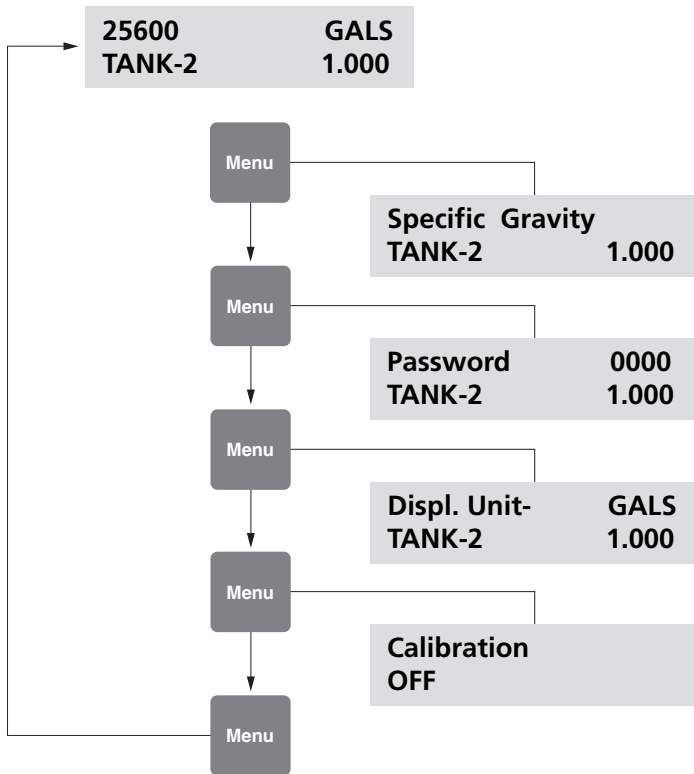

### MENU Options

The LP2 indicator has four (4) user-addressable selections that are accessible with the MENU key.

- Specific Gravity - Shows the specific gravity value in current use for the tank being viewed.
- Password - Optional password 4-digit value to restrict access to specific gravity edit mode.
- Displ. Unit - Shows current display unit (LBS, GALS, etc.) for the tank selected.
- Calibration - OFF (normal display mode); ON displays A/D counts for diagnostic purposes.

**(Note:** If the password protection is engaged, the "Password" menu selection will not be displayed.)



**LP2 Front Keypad**



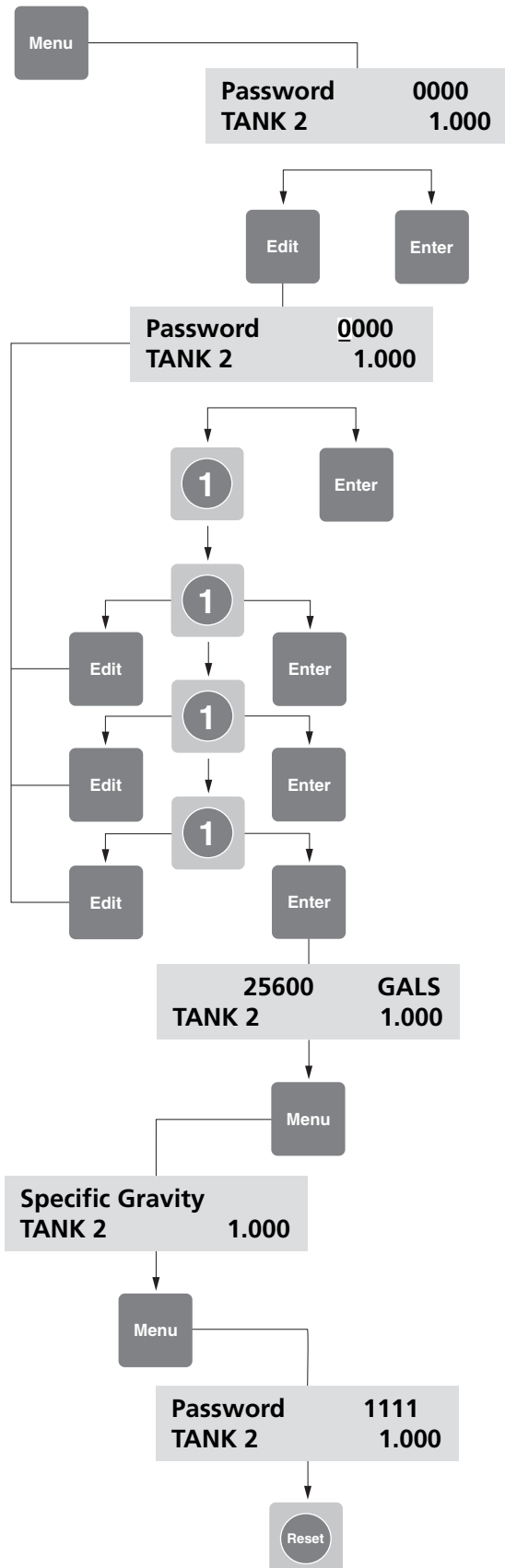

## LP2 Display Modes

### Password

The LP2 indicator offers a “password” lockout for specific gravity input (see page 8). By default this value is the disable setting of 0000 in which the lockout feature is not active. To activate the password lockout, press EDIT and overwrite the 0000 code with any 4-digit number. The new password code will be displayed on the Menu Options display, but the lockout feature will not be active.

To engage the lockout, press the RESET key to engage password lockout. Subsequent attempts to edit the current specific gravity value will prompt user for the “password” code.

TO DEACTIVATE LOCKOUT - Use the MENU key to access Specific Gravity and press EDIT. This will prompt you to enter the current “password” code. Once entered, press MENU to display the password setting, then press EDIT. You must enter the code 0000 and press RESET to disable the password lockout.

### Calibration Mode

The “calibration” mode sets the LP2 processor to read directly in A/D counts (0-4096) corresponding to the milliamp signal input value (4-20 mA). The readout will include a “C” status character following the A/D value in the upper display line. This may be useful for some troubleshooting procedures.

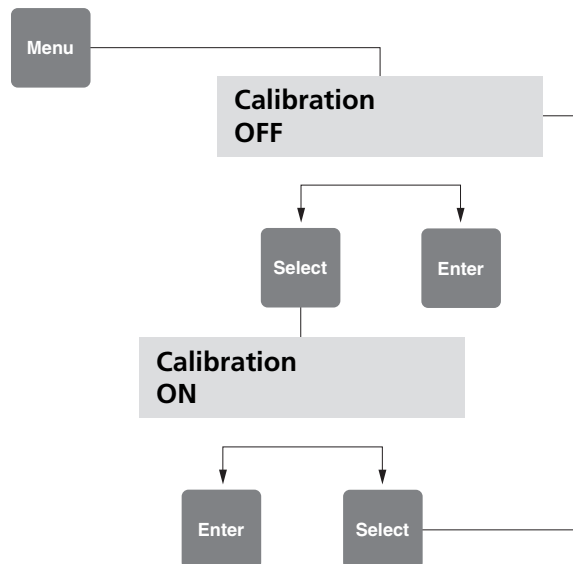

## LP2 Display Modes

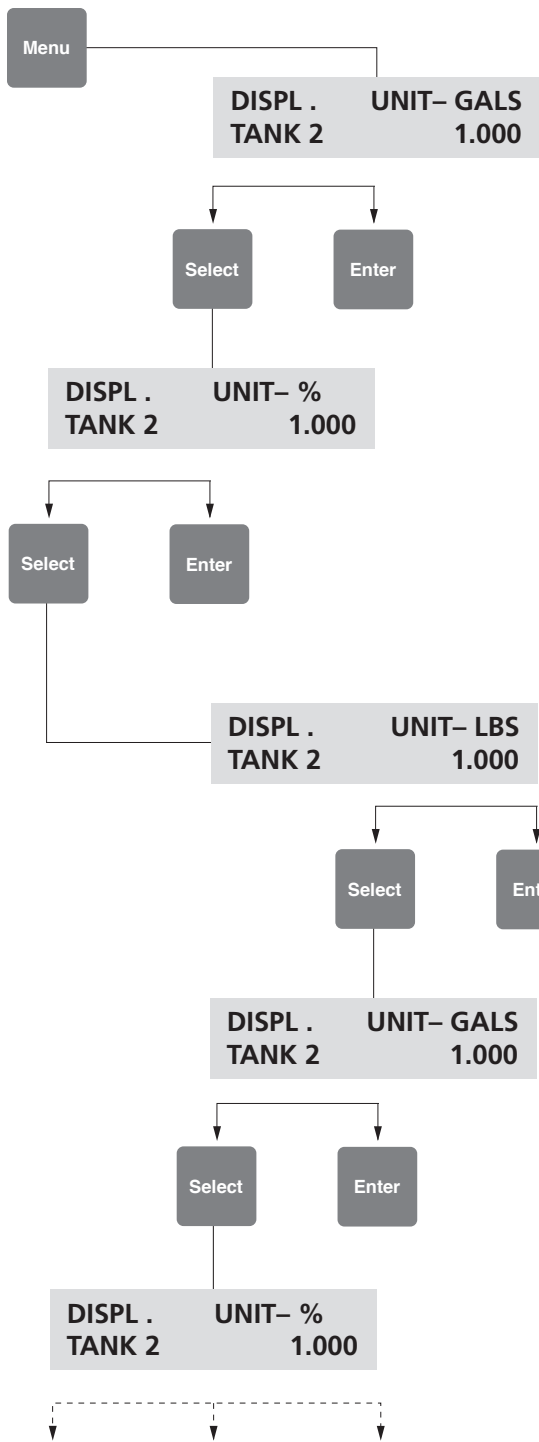

### Selecting Display Units

To change the readout units, use the keypad at the Main Processor. Press the MENU key. "SP.GRAVITY" appears on the display. Press the MENU key again for the "UNITS" display. Then use the SELECT key to sequence through the readout units selections. When the desired readout unit is displayed, press the ENTER key to accept the selection and return to the tank level display mode.

Certain problems experienced during initial system installation and start-up may result from incomplete connections. Optimum performance will occur when power and cabling recommendations are followed.

### No Display

Unit does not appear to be functioning and nothing appears on the LCD panel.

- Make certain that Tank Processor is connected to 115 Vac power source.
- Check internal fuse(s) on internal board set of Tank Processor and replace if necessary.

### Low Reading

Level value being displayed is inaccurately low, or does not rise when level increases.

- Check sensor/transmitter output (if necessary, check zero and span settings).
- Signal connections are reversed at the tank processor input terminals or were reversed at the transmitter terminals.
- Resistive load on signal loop exceeds capacity of transmitter at the supplied 24 Vdc excitation from the Tank Processor.

### High Reading

Level value being displayed is inaccurately high.

- Check sensor/transmitter output (if necessary, check zero and span settings).
- Check that tank vent is open. (Rapid fill rate may sometimes exceed venting capacity creating internal pressure in the tank.)
- Specific gravity of liquid in tank may be greater than that programmed into tank processor Datapack iButton. Check that the specific gravity value (lower right hand corner) being displayed for that tank is correct.

## Communications Troubleshooting Using LED Status Indicators

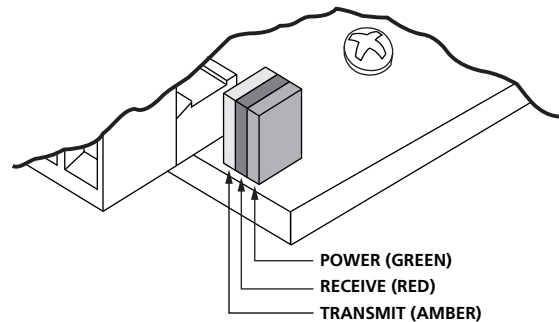

### GREEN On = Power is On

### GREEN Off = Power is Off

The green LED is illuminated when power is supplied to the unit. If the green LED is not lit, check that the external power supply is connected to unit. (Internal fuse may also be blown.)

### AMBER On (Blinking) = Data Transmit

### AMBER Off = Not Transmitting

The amber LED is illuminated during each data pulse transmission. During normal operation, the LED will be blinking on/off in combination with the red (receive) LED. If the receive (red) LED is functioning but there is no indication from the amber LED, unit may have an internal component failure.

### RED On (Blinking) = Data Received

### RED Off = No Data Received

### RED Always On = RS-485 A + B Line Reversed

The red LED is illuminated in response to each data pulse received. During normal operation, the LED will be blinking on/off in combination with the amber (transmit) LED. If there is no indication from the red LED, there may be a problem with the data format from the host. If the red LED is continuously illuminated, this indicates a crossed connection between the A + B sides of the RS-485 two wire interface (try reversing the A + B connections at the LP2).

## LP2 Diagnostic Codes

### System Errors 1-50

|                                |    |
|--------------------------------|----|
| Shorted iButton .....          | 1  |
| Not Detected iButton .....     | 2  |
| Write Error iButton.....       | 10 |
| Write Timeout iButton .....    | 11 |
| Write not completed.....       | 12 |
| Read Error iButton .....       | 15 |
| Dir not found iButton.....     | 20 |
| Dir bad system page .....      | 21 |
| Dir bad tank page.....         | 22 |
| Bad page length .....          | 30 |
| No first page.....             | 31 |
| Tank data end not marked ..... | 32 |
| Tank data checksum wrong.....  | 33 |
| End of tank data wrong .....   | 34 |
| CRC Error .....                | 35 |
| End of file.....               | 36 |
| Bad tank number .....          | 40 |

### Tank Errors 51-100

The tank will be in cal mode, with no response to serial request for data.

|                                |    |
|--------------------------------|----|
| Shorted iButton .....          | 51 |
| Undetected iButton.....        | 52 |
| Write error iButton.....       | 60 |
| Write timeout iButton .....    | 61 |
| Write not completed.....       | 62 |
| Read error iButton .....       | 65 |
| Dir not found.....             | 70 |
| Dir bad system page .....      | 71 |
| Dir bad tank page.....         | 72 |
| Bad page length .....          | 80 |
| No first page.....             | 81 |
| Tank data end not marked ..... | 82 |
| Tank data checksum wrong.....  | 83 |
| End of tank data wrong .....   | 84 |
| CRC error .....                | 85 |
| End of file.....               | 86 |
| Bad tank number .....          | 90 |
| A/D Converter error .....      | 99 |

### Informational Errors 101-255

System and tank calculation are functional

|                                    |     |
|------------------------------------|-----|
| Setpoint fails to initialize ..... | 101 |
| Setpoint fails SP1 .....           | 102 |
| Setpoint fails SP2 .....           | 103 |
| Setpoint fails data .....          | 104 |
| Setpoint failure in iButton .....  | 105 |
| Setpoint fails update .....        | 106 |
| Watchdog timeout.....              | 110 |

## ASCII Message Structures

### Query Sequence (PLC)

The PLC transmits a query to a specific LP2 processor (ADDRESS) to read (FUNCTION) the values from register (STARTING REGISTER HI/LO) through register (# OF REGISTERS HI/LO) with the check (CRC).

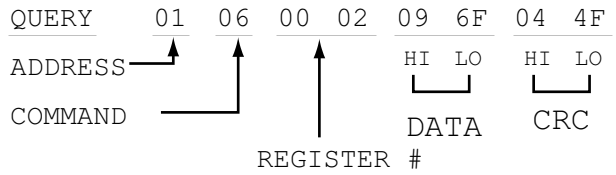
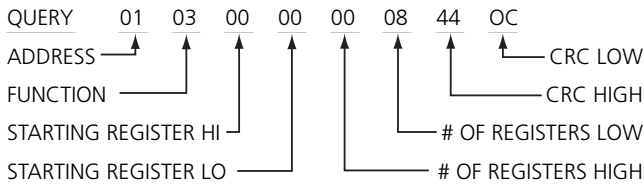

### Data Packets

The data packets are transmitted sequentially beginning with the starting register (00). Since there are two bytes per register, the initial byte count in the message string confirms the number of register values that are transmitted.

### Response Sequence (LP2)

The specified LP2 (ADDRESS) responds to the query (FUNCTION) noting how many data packets (BYTE COUNT) being sent and the values (DATA) followed by the check (CRC).

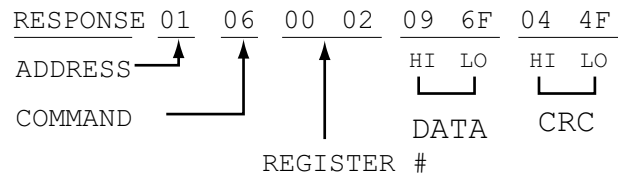

### Specific Gravity Write (PLC)

The PLC transmits a command to a specific LP2 (ADDRESS) to write (FUNCTION) to a specific register (REGISTER#) a new gravity value (DATA) followed by the check (CRC).

### Specific Gravity Write (LP2)

The LP2 (ADDRESS) acknowledges the write command (FUNCTION) and echos the gravity value (DATA) followed by the check (CRC).

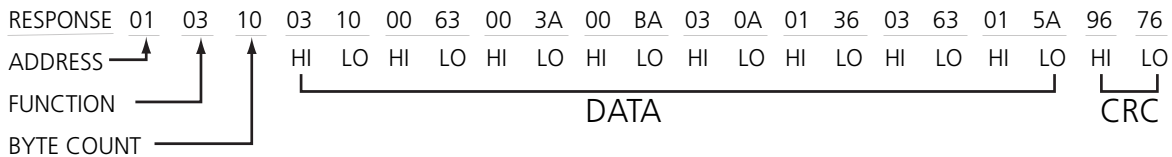

| Communications Port Protocols |                  |
|-------------------------------|------------------|
| Port A<br>ASCII               | Port B<br>Modbus |