

Model LP3

Effective: January, 2012

DATA SHEET 1600-20

- Ethernet/IP, DF1 over Ethernet/IP, Allen-Bradley DH485, Modbus TCP/IP
- Graphic 10.4" Color LCD Touch Screen Terminal HMI
- 8-Tank, 16-Tank, 24-Tank, 32-Tank System Options
- Preconfigured Tank Capacity (Volumetric) Database



Complete level monitoring system

The new KING-GAGE LP3 tank level system is designed for greater flexibility within today's process environment. Combining data acquisition with a complete HMI display and plant integration solution, KING-GAGE LP3 system works in processing environments with multiple tanks or process vessels requiring level measurement and inventory monitoring. The LP3 system can eliminate the need for dedicated I/O typically employed by a PLC or other process control device.

Multiple Tank Configurations

These multiple tank systems are available in 8-tank, 16-tank, 24-tank and 32-tank configurations. Factory installed hardware (Vdc loop power, analog input modules) provide for virtual plug and play installation. Plus, the LP3 operating system makes it easy for your personnel to set display preferences.

The analog input module(s) provide complete processing of the transmitter signal loops (4-20 mA) when used with two wire level sensors or D/P transmitters. The input module scales the transmitter signal for specific tank geometry to calculate a volumetric (or mass) measurement.

Operator Interface HMI

An intuitive operator display panel depicts tank levels with capability to include setpoints (alarm) monitoring. Change to the spreadsheet view for product scheduling or inventory reporting. Specific tank status details are available in a simple drill-down page for commissioning or troubleshooting. The 10.4-in. TFT color display is mounted within a Stainless Steel enclosure or as a flush mounting remote panel.

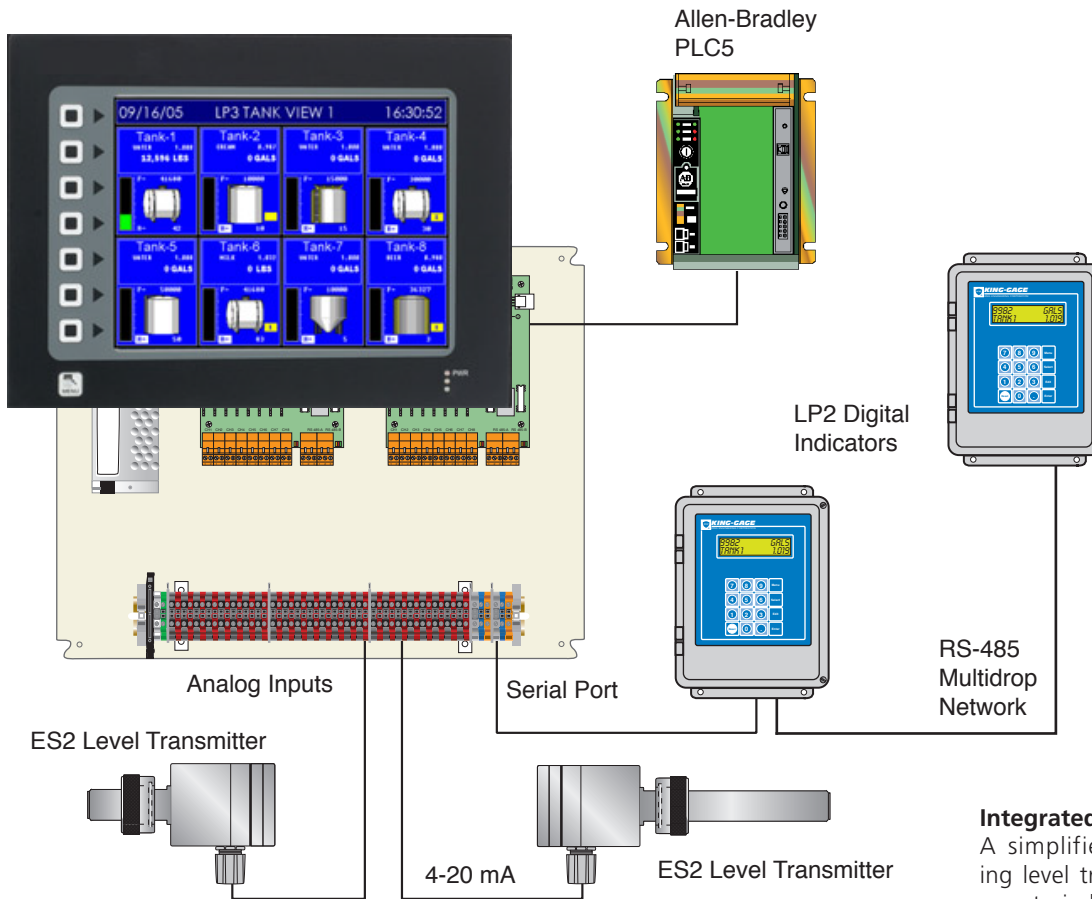

Integrated System View

A simplified overview showing level transmitters, external remote indicators and network interface to a PLC5 (using DF1 over Ethernet or DH485).

Signal Processing and More

LP3 system uses specialized processor modules that read the transmitter 4-20 mA signals. These inputs are digitized, scaled (linearized) and converted into volumetric or fluid mass measurement units by correlating to the specific tank geometry. This programming is pre-configured at the factory with data typically generated by dimensional information from a tank manufacturer’s plan drawing. Alternatively, volumetric capacity may be taken from an available strapping table or through a physical wet calibration of a tank.

While it is common to input level transmitter signals directly to analog I/O cards at the PLC, this approach requires considerable investment into the controller’s programming (especially for horizontal tanks or other non-linear vessels). Since the LP3 system accomplishes the A/D conversion process, it eliminates the need for the PLC to allocate and manage I/O specifically for the transmitter inputs. More

importantly, by performing the scaling functions independently, it frees up the PLC to focus on the batching and control functions (with register values loaded directly from the LP3 interface).

The benefits of this approach include better data integrity with PLC performance now dedicated to more critical aspects of your process. Because data acquisition is an integral function of the KING-GAGE LP3 system, coupled with the network connectivity including Ethernet, it is much simpler to share tank level inventory data across the process floor or even to a corporate enterprise. (Refer to Process Control Integration description on page 4.)

LP3 system software affords a high degree of accuracy and security. HMI display configurations are stored in FLASH memory while application data is isolated within an iButton datapack (non-volatile RAM).

Display Modes and User Menus

The LP3 system has been designed to function for plant operations personnel while providing a level of data security to assure peace of mind. There are three (3) levels of password access to permit local or remote administrative functions.

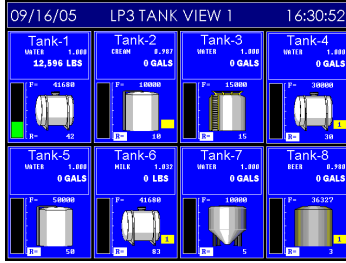

LP3 Tank View Display

Up to 8 concurrent tanks graphically displayed on each screen (with support for four separate Tank View pages). Combine optional level set points for a complete monitoring solution designed to be user-friendly. A simple bargraph icon conveys tank level status at a glance.

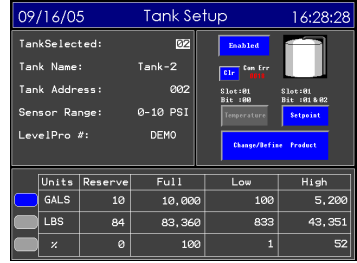

LP3 Drill Down Detail

The color touchscreen allows quick access to details including engineering units selection, tank capacity, and communications status. Configuration settings are readily visible from each tank's detail screen. (Access to these settings is password-protected to ensure data integrity.)



LP3 Inventory Status Display

Simultaneously view levels for up to 24 tanks with dynamic horizontal bargraph (representing % full status). The concise listing by tank name, product designation, and current inventory level (volume or weight) easily lends itself to production reporting.



Change/Define Products

You can change the current tank product by accessing the menu listing available product designations by name and density (showing specific gravity value). The current selection is highlighted by a blue indicator button.

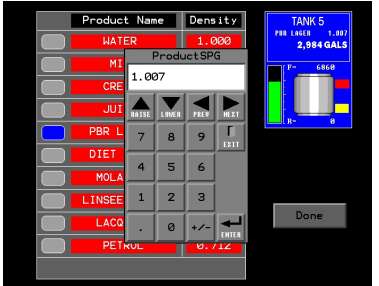

Operator or Admin Access

if you are password entered into this access level, you can edit the product name or add a new product designation to the list (and enter a specific gravity value). Simply touch the existing text or touch an unused position to launch the on screen entry keypad.

Complete System Package

The LP3 system is a complete tank liquid level measurement solution that includes signal conditioning, data acquisition and network communications link(s).

System power and external excitation for the signal loops, analog input modules (signal conditioning and data processing) and HMI color touch screen terminal are furnished within a NEMA rated brushed Stainless Steel enclosure.

HMI is the industry acronym for human machine interface or more commonly, the operator interface terminal. This is the part of the system the user interacts with directly by viewing the tank displays or selecting menu options via the touch screen.

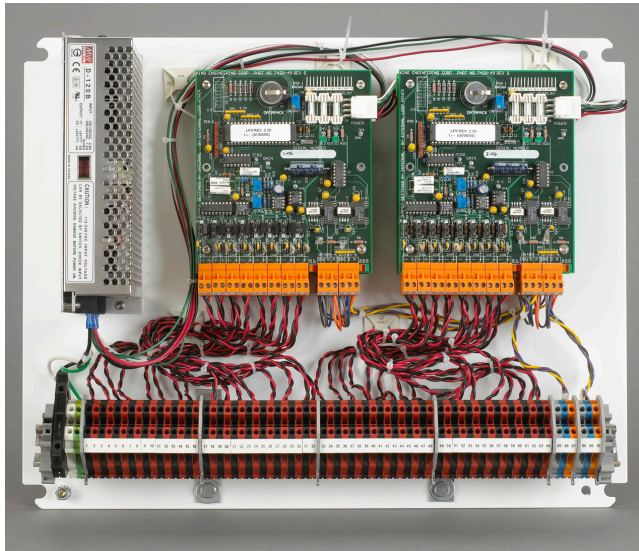

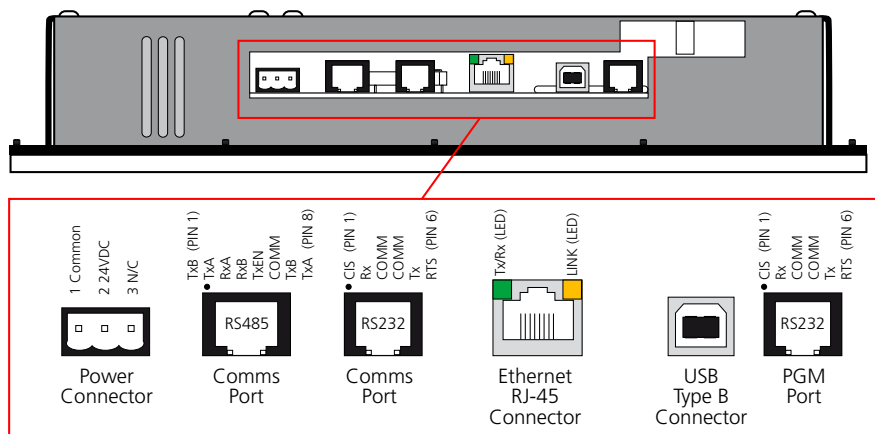
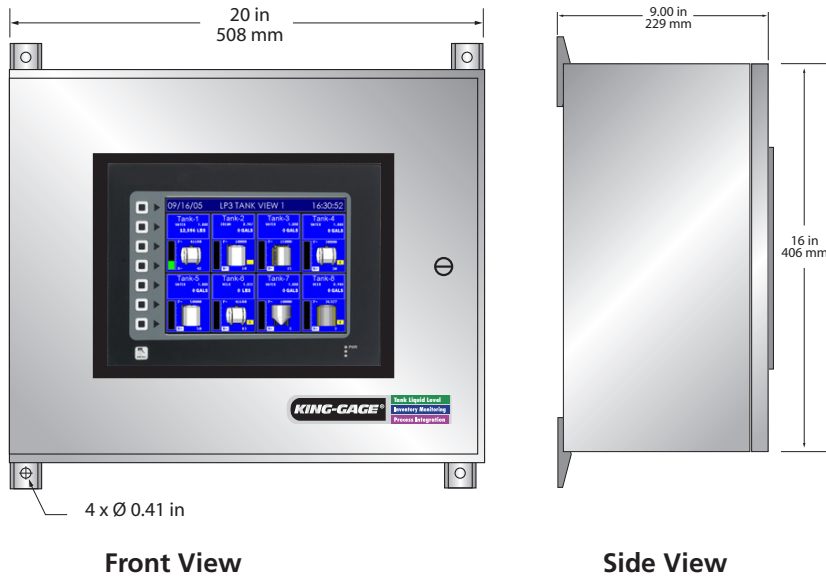

Process Control Integration

The built in digital communications capability of the LP3 system can simplify the integration of tank level into your process control environment. The LP3 has provision for Ethernet, USB, RS485, RS232C to support up to 4 high-speed serial ports to communicate to PLCs, SCADA systems or even your enterprise network.

Network protocols directly supported by LP3 include Modbus TCP/IP, Allen-Bradley DF1, Allen-Bradley DH485 and KING-GAGE KingBus ASCII. Additionally, LP3 can provide remote viewing over Ethernet using standard HTML browsers (Internet Explorer, Netscape, etc.) via its integrated web server. Imagine inventory data available at remote locations within your facility or beyond.

LP3 Specifications

HMI Display Panel
Color 10.4-in. LCD, active matrix (TFT), 640 x 480 VGA (256 colors), resistive analog touch screen

External Memory
CompactFlash Type II slot

Network Drivers
Ethernet/IP
Allen-Bradley DF1 over TCP
Allen-Bradley DF1 / DH485
Modbus TCP/IP
Kingbus ASCII

Serial Ports
Ethernet 10 Base-T/100 Base-TX (RJ45)
RS485 (RJ12)
RS232 (RJ12)
USB 1.1 (Type B)

External Power Requirements
110-120 VAC, 50/60 Hz, 2.8 Amperes
(internally fused at 6.3 A)

Signal Inputs
4 mA to 20 mA, two wire (w/ 24 VDC excitation option);
8-32 input channels

Operating Temperature Range
32 °F to 125 °F (0 °C to 50 °C)

Enclosure
Type 4X (UL50), IP 66, 304 Stainless Steel, hinged latching cover

Standard System Configurations

8-tank system; 16-tank system; 24-tank system; 32-tank system (includes HMI, analog inputs, power supply)

Enhanced System Configurations

8-tank system; 16-tank system; 24-tank system; 32-tank system (includes HMI, analog inputs, analog outputs, power supply)